

HANNSpree

HANNSpree, Inc.  
2F, No.362, Jui-Kuang Rd., Neihu District,  
Taipei City 114, Taiwan, R.O.C.  
TEL: 886-2-87520000  
FAX: 886-2-87527092  
[www.hannspree.com](http://www.hannspree.com)

NTSCTVTWEN1202  
MAC-001038

HANNSpree

# 12.1" Liquid Crystal Display Television

## F651-12A1

User's Manual

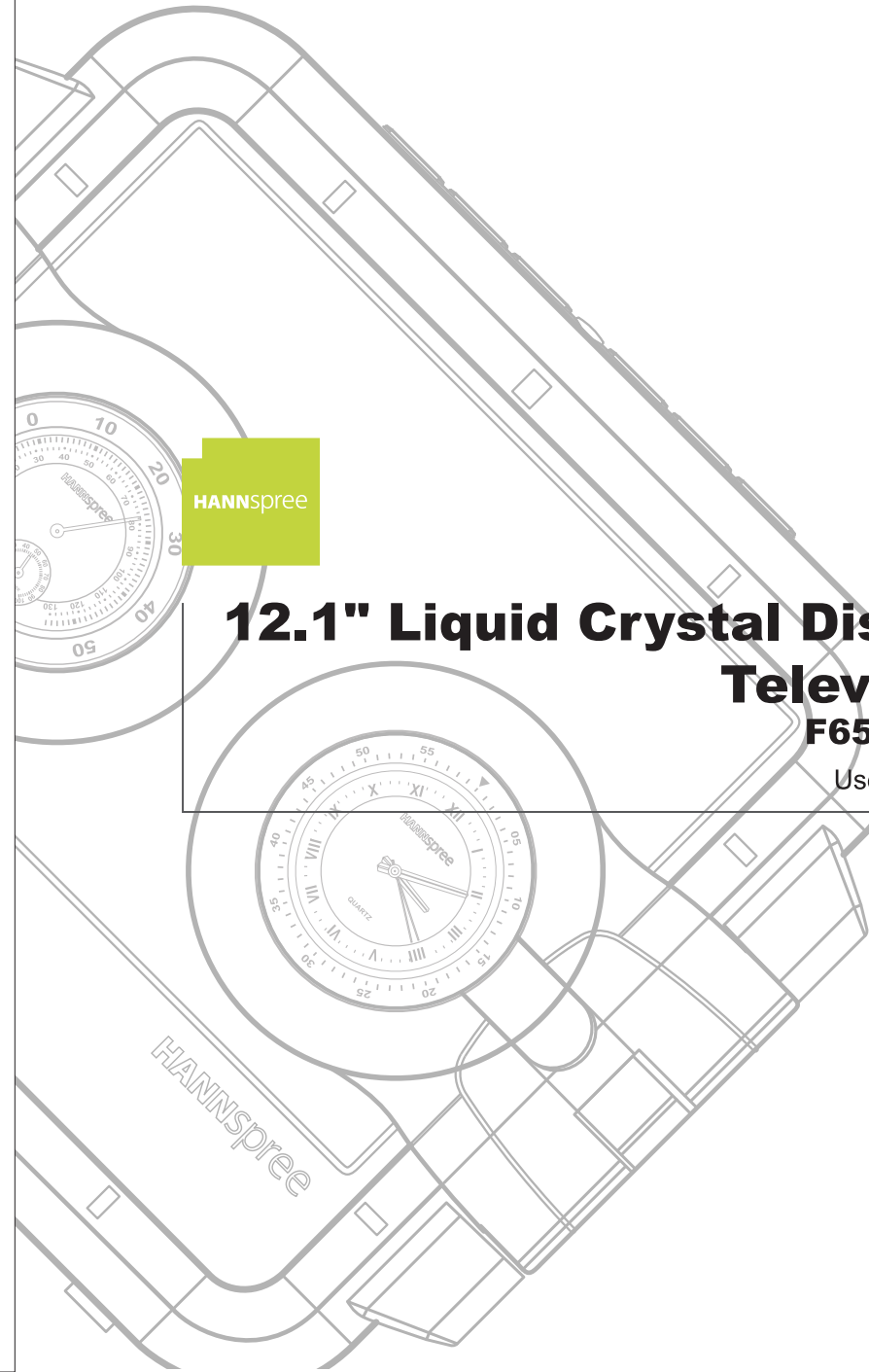

# Table of Contents

1. Warranty and Service .....	3
2. Preface .....	4
3. Description of Warning Symbols.....	5
4. Safety Notices .....	6
5. Regulatory Information .....	14
6. Introducing the TV .....	16
Features.....	16
7. Checking Package Contents .....	17
8. Getting to Know Your TV .....	18
Front View .....	18
Input and Output Ports .....	19
9. Getting Started.....	20
Placing the Clock and Thermometer/Hygrometer .....	20
Removing the Clock and Thermometer /Hygrometer ..	21
Connecting to an Antenna or Cable TV .....	22
Connecting to AV Devices .....	23
Connecting to a VCR/VCD/DVD Player .....	23
Connecting to a Video Camera .....	24
Connecting to a Game Device .....	25
Connecting External Speakers or Headphones.....	26
Connecting the Power Adapter .....	27
10. Using the TV .....	28
Using the Remote Control .....	28
Turning the TV On and Off .....	29
Selecting Channels .....	29
Switching Source Sigals.....	30
Adjusting the Volume .....	30

# Table of Contents

11. Adjusting On-Screen Display (OSD) Settings .....	31
Brightness .....	32
Contrast .....	33
Video Setting .....	34
Hue .....	35
Saturation .....	36
Sharpness .....	37
Color Temperature .....	38
Audio Setting .....	39
Treble .....	40
Bass .....	41
Balance .....	42
TV Setting .....	43
TV/CATV .....	44
MTS .....	45
Auto Program .....	46
Manual Program .....	47
Channel Add/Erase .....	48
Miscellaneous Setting .....	49
OSD Position .....	50
Language .....	51
Sleep Timer .....	52
OSD Display .....	53
Reset .....	54
12. Taking Care of Your TV .....	55
13. Troubleshooting .....	57
14. Specifications .....	59
15. Glossary .....	60

The instructions on this manual are for the model(s) listed on the front cover. Before you start reading, check your product number by looking at the rear of your TV.

Thank you for purchasing our Liquid Crystal Display Television (LCD TV). With this product, you will be able to enjoy superior audio and video while enriching your lifestyle with advanced technology.

The Hannspree TV is warranted for one year limited service from the date the product is received (as shown on the Warranty and Service Manual); please refer to the “Warranty and Service Manual” for the detailed warranty information.

Hannspree provides complete service information in the included “Warranty and Service Manual”, or directly from Hannspree global customer service center. Our service representatives will be very happy to serve you to your satisfaction.

Hannspree global customer service center telephone number:  
From Taiwan please call 0800-008-800

The Hannspree e-mail address:  
[service@hannspree.com](mailto:service@hannspree.com)

This manual is designed to assist users in setting up and using the LCD TV. Information in this document has been carefully checked for accuracy; however, no guarantee is given to the correctness of the contents. The information in this document is subject to change without notice.

### **Copyright**

© Copyright 2003 Hannspree, Inc.

All rights reserved. This product and related documentation are protected by copyright and are distributed under licenses restricting their use, copying, and distribution. No part of this documentation may be reproduced in any form by any means without prior written authorization of Hannspree, Inc., and its licensors, if any.

### Warning



This symbol is used to remind users to pay attention to important descriptions regarding usage and maintenance (repair) or additional important information related to this product.

### Caution



This symbol is used to remind users to pay attention to the danger of electric shocks due to dangerous internal non-insulated components.

### Electric Power Notice

Electric power may cause personal injury and mechanical damage if it is misused. Although safety has been taken into consideration during the design and production of this product, electric shock or fire can result when the product is misused. To prevent potential danger, follow the instructions below when installing, operating and cleaning the product. In addition, read the following “Safety Notices” carefully before using the product to ensure that your TV is safe and long-lasting.

**Power Supply Safety Notes**

1. To avoid electric shocks, do not use an extended power cord or an outlet that does not match this product's plug or leaves the plug exposed.
2. This product has a 3-pin grounded plug. The third pin connects to ground; do not remove it.
3. If the power cord or plug is damaged or worn, unplug it immediately and contact a qualified service technician for maintenance.
4. To avoid fire or electric shocks, do not overload electric power outlets.

**Installation Safety Notes****Antenna**

We suggest that you use an outdoor antenna to get the best signal possible unless you have cable TV or a centralized indoor antenna system. You may, however, use an antenna indoors if it is placed in a location free from interference.

**Location**

Avoid allowing the TV to get prolonged exposure to sunlight or other strong sources of heat. Leave sufficient distance between the TV and the wall to provide enough space for the emission of heat.



### **Before You Proceed**

1. Read the Safety Notices and the User's Manual carefully before turning the product on.
2. Keep your User's Manual in a safe place for future reference. Keep the box and packaging in case the product needs to be shipped in the future.
3. Follow the product and warning label instructions.
4. Any changes or modifications that do not follow the instructions in this manual will void this product's warranty.



### **Warning**

To reduce the risk of fire or electric shock, do not expose this product to rain or moisture.



### **Power**

To avoid danger of fires or electric shock, make sure that you use a proper adapter. The TV is compatible with the following adapters:

- EDAC POWER ELECTRONICS CO., LTD.: EA 1050E-120
- LI SHIN INTERNATIONAL ENTERPRISE CORP.: 0217B1240



---

## Optimal Viewing Distance

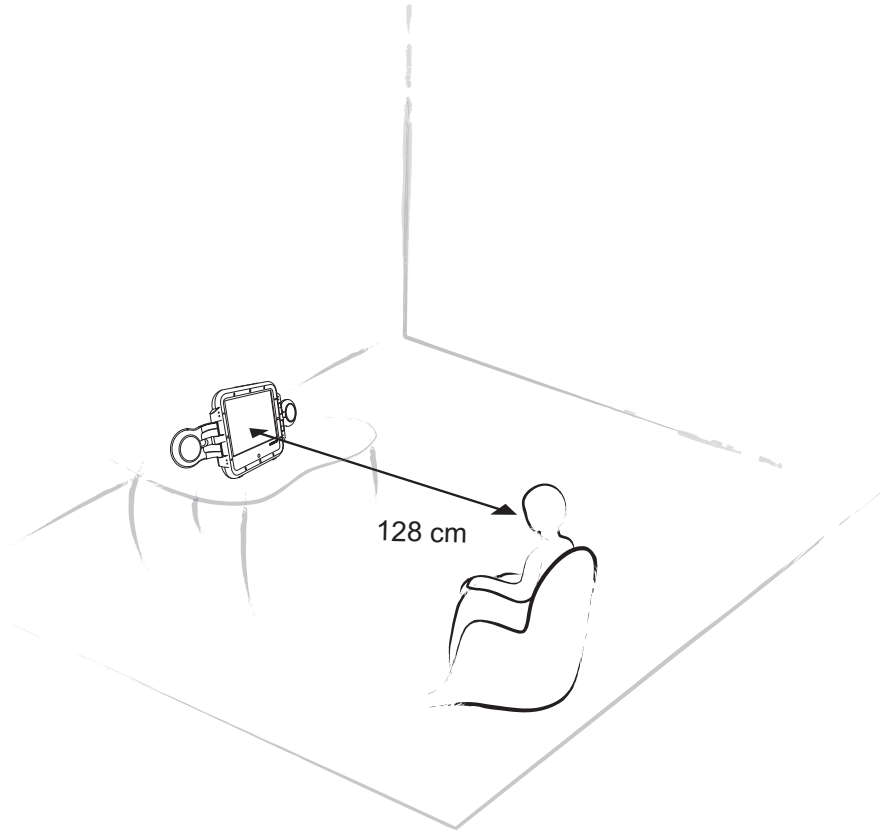

---

## Important Safety Instructions

---



1. Read these instructions.
  2. Keep these instructions.
  3. Heed all warnings.
  4. Follow all instructions.
- 



5. Do not use this apparatus near water.
- 



6. Clean only with a dry cloth.
- 



7. Do not block any ventilation openings. Install in accordance with the manufacturer's instructions.
- 



8. Do not install near any heat sources such as radiators, heat registers, stoves, or other apparatus (including amplifiers) that produce heat.
- 

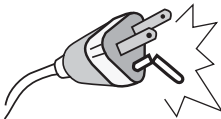

9. Do not defeat the safety purpose of the polarized or grounding-type plug: A polarized plug has two blades with one wider than the other. A grounding type plug has two blades and a third grounding prong. The wide blade or the third prong are provided for your safety. If the provided plug does not fit into your outlet, consult an electrician for replacement of the obsolete outlet.
-

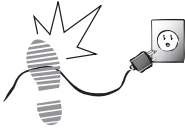

10. Protect the power cord from being walked on or pinched particularly at the plug, convenience receptacles, and the point where they exit from the apparatus.



11. Use only with a cart, stand, tripod, bracket, or table specified by the manufacturer, or sold with the apparatus. When a cart is used, use caution when moving the cart/apparatus combination to avoid injury from tip-over.



12. Only use attachments/accessories specified by the manufacturer.



13. Unplug this apparatus during lightning storms or when unused for long periods of time.



14. Refer all servicing to qualified service personnel. Servicing is required when the apparatus has been damaged in any way, such as if the power-supply cord or plug is damaged, liquid has been spilled or objects have fallen into the apparatus, the apparatus has been exposed to rain or moisture, does not operate normally, or has been dropped.

---

## Personal Safety

---

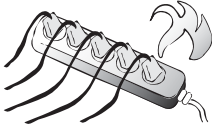

To avoid overloading the power supply, do not plug too many electrical devices into an outlet or extension cable.

---

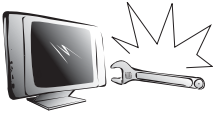

Dangerous high-voltage electric power components are located inside the TV. To avoid electric shock, do not disassemble the casing.

---



Do not place or drop metals, small objects, or flammable materials in the vent to avoid an electric shock or a fire.

---



If the TV is dropped, falls down, or is otherwise damaged, unplug the power cord immediately and notify a qualified service technician.

---



If any fluid is sprayed or dropped into the TV, remove the power plug immediately and notify a qualified service technician.

---



The screen of the TV is made of glass, be careful to avoid hitting or scraping it. If the screen is broken, avoid cutting yourself on the broken glass.

---



Do not allow children to use the TV unattended to avoid accidents caused by improper operation.

---

---

## Installation

---



To avoid damage to power circuits, do not place the TV in locations where there is excessive steam or dust.

---



Do not place the TV on a bed, sofa, carpet, or in a sealed cabinet to avoid blocking the product's vents.

---

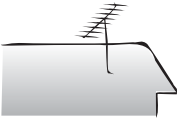

Install the outdoor antenna far from power transmission lines to avoid possible danger.

---



Remove the power cord and antenna connector when there is a storm or when the TV is not in use for a long period to avoid electric shock from lightning.

---

## Operation

---



This product is designed for power sources as labeled on the casing. Avoid using any other power accessories to avoid electric shock or other damage.

---



The plug can be inserted into an outlet in only one direction. Notify a qualified service technician if you cannot plug it in correctly.

---



If there is any problem that cannot be resolved according to the instructions given in this manual, notify a qualified service technician immediately. Do not attempt any methods not covered in this manual.

---

## Maintenance

---



Do not attempt to repair the TV by yourself. Notify a qualified service technician. Ask the service technician to complete a safety inspection before switching the power on after completing any maintenance.

---

### **FCC Compliance Statement<sup>1</sup>**

This device complies with part 15 of the FCC Rules. Operation is subject to the following two conditions: (1) This device may not cause harmful interference, and (2) this device must accept any interference received, including interference that may cause undesired operation.

This equipment has been tested and found to comply with the limits for a Class B digital device, pursuant to part 15 of the FCC Rules. These limits are designed to provide reasonable protection against harmful interference in a residential installation. This equipment generates, uses and can radiate radio frequency energy and, if not installed and used in accordance with the instructions, may cause harmful interference to radio communications. However, there is no guarantee that interference will not occur in a particular installation. If this equipment does cause harmful interference to radio or television reception, which can be determined by turning the equipment off and on, the user is encouraged to try to correct the interference by one or more of the following measures:

- Reorient or relocate the receiving antenna
- Increase the separation between the equipment and receiver
- Connect the equipment into an outlet on a circuit different from that to which the receiver is connected
- Consult the dealer or an experienced radio/TV technician for help

**Warning:** A shielded-type power cord is required in order to meet FCC emission limits and also to prevent interference to nearby radio and television reception. It is essential that only the supplied power cord be used. Use only shielded cables to connect I/O devices to this equipment. You are cautioned that changes or modifications not expressly approved by the party responsible for compliance could void your authority to operate the equipment.

---

1. applies only to products purchased in the United States of America

---

## **DOC Compliance Notice<sup>1</sup>**

This digital apparatus does not exceed the Class B limits for radio noise emissions from digital apparatus as set out in the Radio Interference Regulations of the Canadian Department of Communications. This device complies with Canada ICES-003 Class B.

## **CE Conformity Statement<sup>2</sup>**

This device complies with the requirements set out in the Council Directive on the approximation of the Laws of the Member States relating to Electromagnetic Compatibility (89/336/EEC) and the Amendment Directive (92/31/EEC), Low-Voltage Directive (73/23/EEC) and the Amendment Directive (93/68/EEC).

- 
1. applies only to products purchased in Canada
  2. applies only to products purchased in the European Union



Thank you for purchasing this Liquid Crystal Display TV. Your LCD TV is designed to be safe, versatile, and easy to use. The design of the product is based on sport watch, which makes it a fun addition to any room.

You can watch broadcast or cable television channels, and easily connect a VCR, VCD, or DVD player or a game device to the standard RCA and S-Video input ports that are included in the 4-IN-1 cable.

Convenient control buttons located on the top of the panel let you change channels, adjust the volume, and change display settings through an easy-to-use on-screen menu system. The built-in stereo speakers provide full, rich sound and a convenient audio output port lets you connect to an external audio system or headphones.

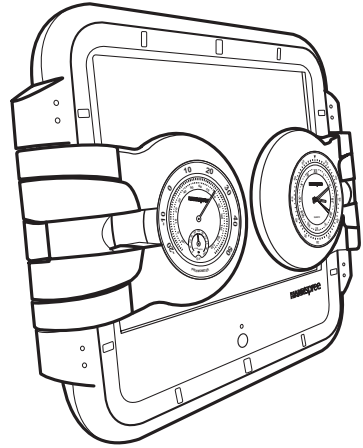

## Features

- 12.1inch color TFT LCD TV
- Safe and sturdy construction
- Built-in TV tuner
- 4-IN-1 cable
- On-Screen Display (OSD) menu system
- Built-in 3W+3W speakers
- Clock and Thermometer/Hygrometer

## Checking Package Contents

Make sure the following components are included in the box. Contact your vendor immediately if anything is missing or damaged.

### TV

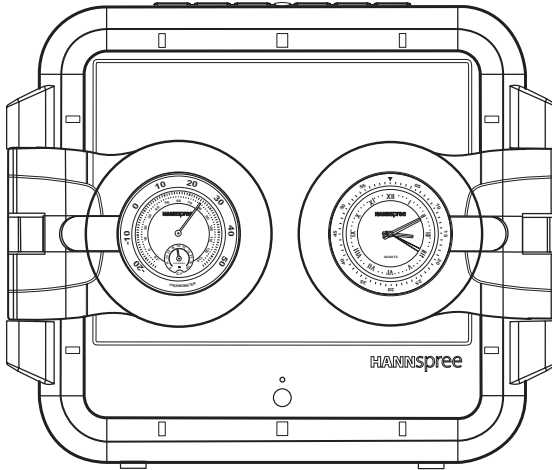

**User's Manual**

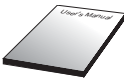

**Quick Start Guide**

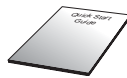

**Warranty and Service Manual**

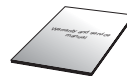

### Wire Material Package

**Power Cord**

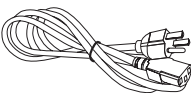

**Power Adapter**

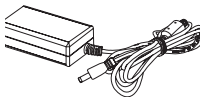

**4-IN-1 Cable**



**RCA Jack x 3**

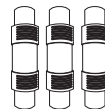

## Front View

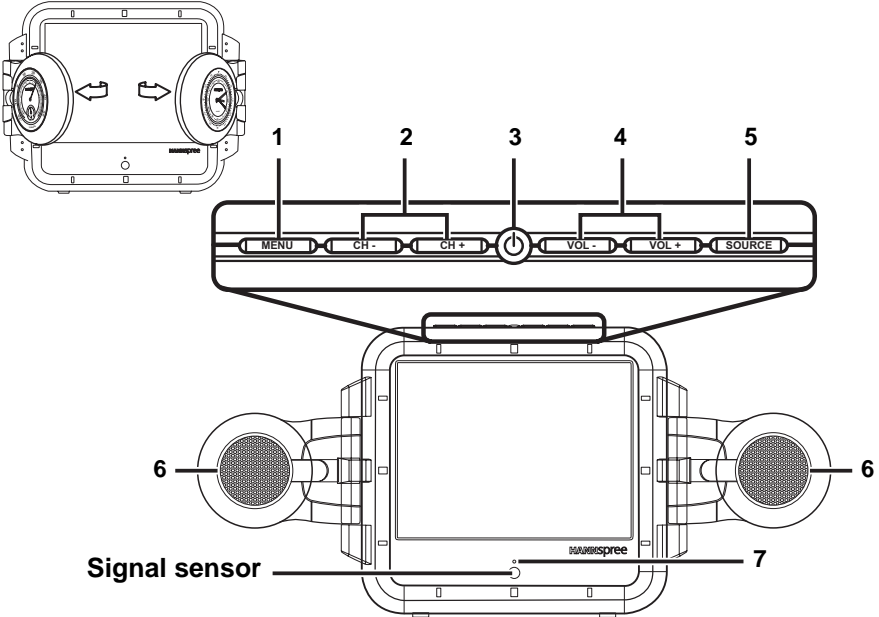

	Description	Function
1	Menu	Turns the On-Screen Display (OSD) menus on and off.
2	Select channel	Changes channels. Press <b>CH +</b> to increase the channel number. Press <b>CH -</b> to decrease the channel number.
3	Power	Turns the TV on and off.
4	Adjust volume	Press <b>VOL +</b> to increase volume. Press <b>VOL -</b> to decrease the volume.
5	Source	Selects the input source to be displayed (TV/CATV, AV, or S-Video).
6	Stereo speakers	Play audio content.
7	Power LED	Green LED indicates power on.

## Input and Output Ports

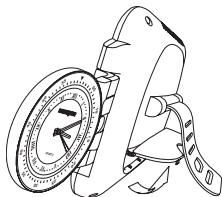

Open the cover before connecting the cable.

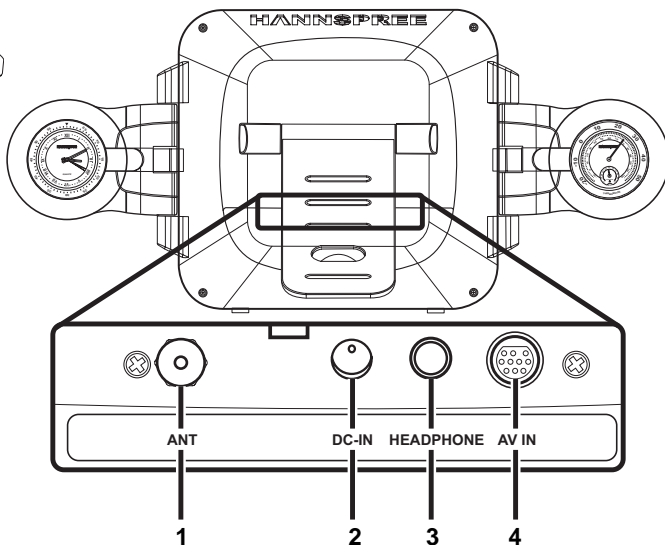

	Description	Function
1	ANT	Connects to an antenna or CATV cable television line.
2	DC-IN	Connects to the included power adapter.
3	HEADPHONE	Connects to headphones or other audio device.
4	AV IN	Connects to VCR/VCD/DVD player CVBS RCA cables or a game device.

## Placing the Clock and Thermometer/Hygrometer

### Clock

1. Turn the clock so that the screw points to the 11 o'clock position as shown (A).
2. Turn the clock face clockwise as shown (B). The clock is locked into place.

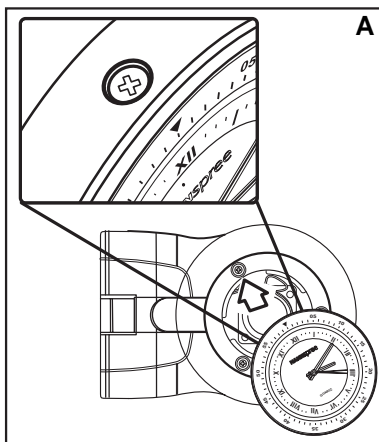
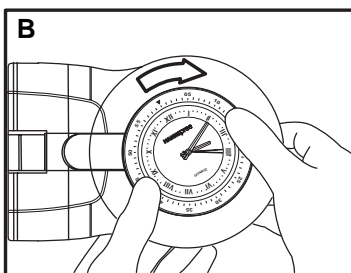

### Thermometer/Hygrometer

1. Turn the Thermometer/Hygrometer so that the screw points to the 5 o'clock position as shown (A).
2. Turn the Thermometer/Hygrometer face clockwise as shown (B). The Thermometer/Hygrometer is locked into place.

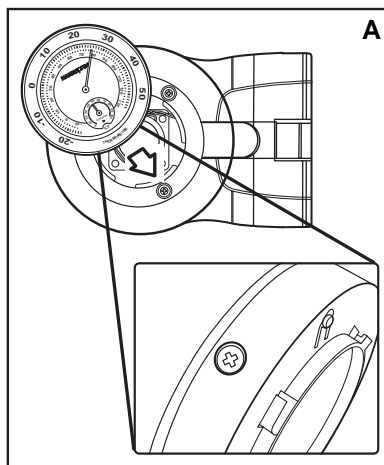
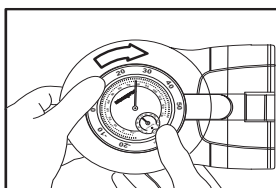

---

## Removing the Clock and Thermometer /Hygrometer Clock

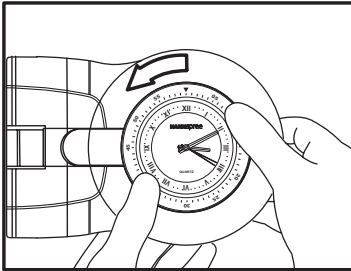

1. Hold the clock and twist it counterclockwise as shown to unlock it.

2. Remove the clock.

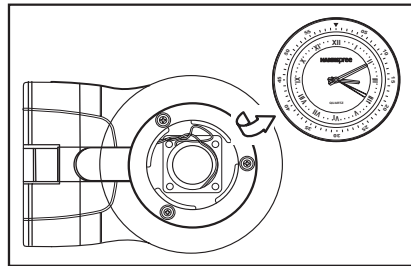

## Thermometer/Hygrometer

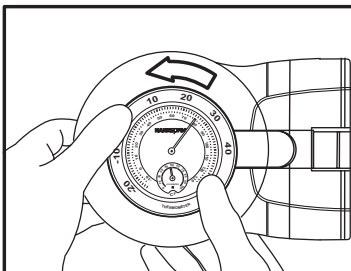

1. Hold the Thermometer/Hygrometer and twist it counterclockwise as shown to unlock it.

**Note:** place your fingers as shown to avoid damage to the LCD panel.

2. Remove the Thermometer/Hygrometer.

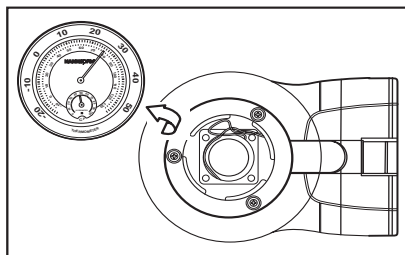

---

## Connecting to an Antenna or Cable TV

- 1 Connect one end of the UHF or CATV cable to the ANT Jack (VHF/UHF IN Jack) on the back of the TV.
- 2 Connect the other end of the VHF/UHF (Antenna) or CATV cable to the antenna socket or CATV cable.

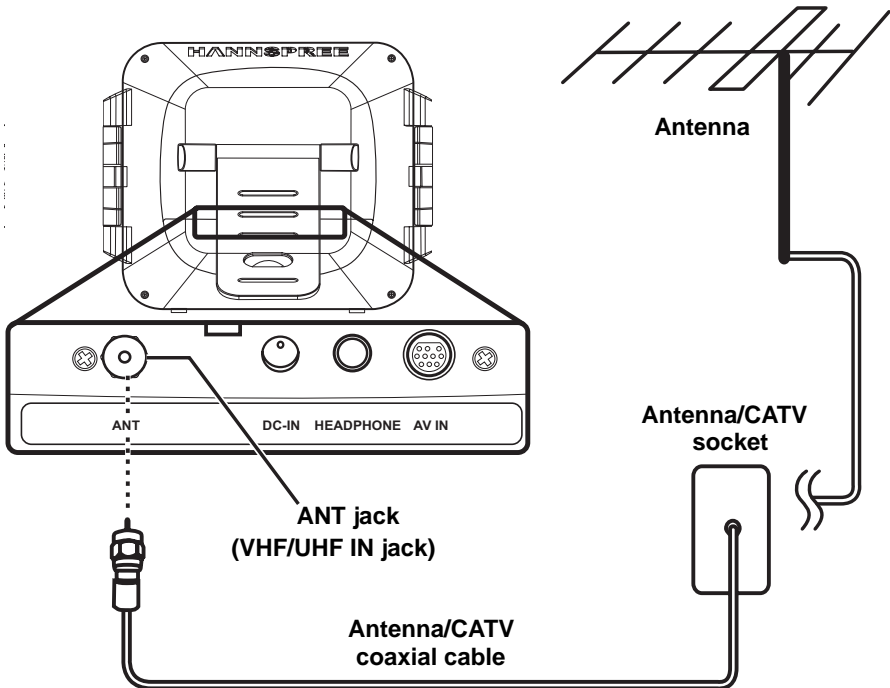

### Note

If you cannot receive channels after connecting to an antenna or cable TV line, try scanning for channels. See “Auto Program” on page 46.

---

## Connecting to AV Devices

Connect external devices such as a VCR, VCD or DVD player, or video game to the TV using the 4-IN-1 cable.

### Connecting to a VCR/VCD/DVD Player

The illustration presented here shows how to connect the TV to a VCR and VCD or DVD player. Actual connections may vary according to the make and model of the device. Refer to the user's manual included with the device for more detailed instructions.

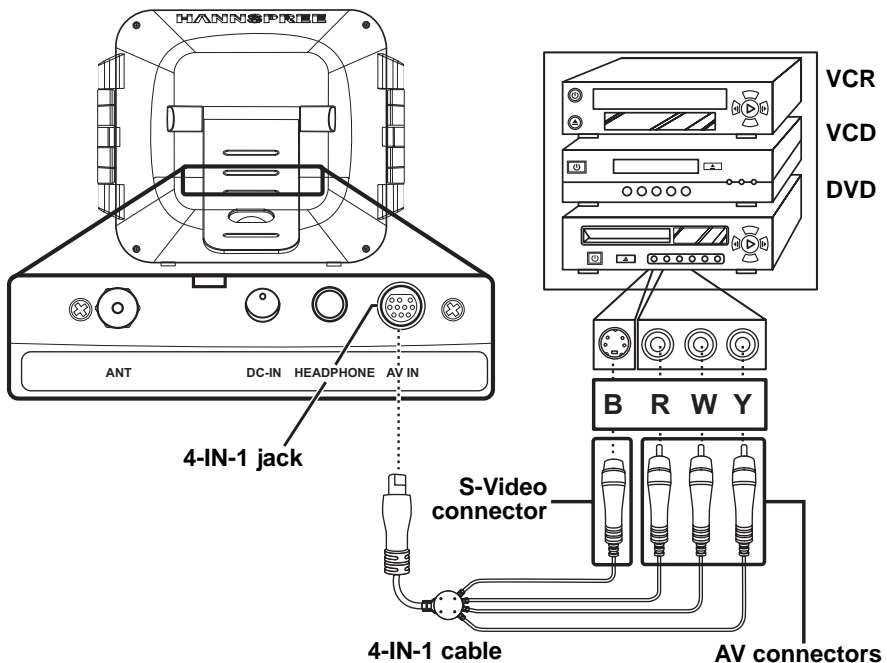

#### Note

The cables are color-coded (black, red, white, yellow). Connect each color-coded cable to the appropriate connector on your device.



---

## Connecting to a Video Camera

The instructions presented here are a general guide to connecting the TV to a camcorder or other type of digital camera. Actual connections may vary according to the make and model of the device. Refer to the user's manual included with the camcorder or camera for more detailed instructions.

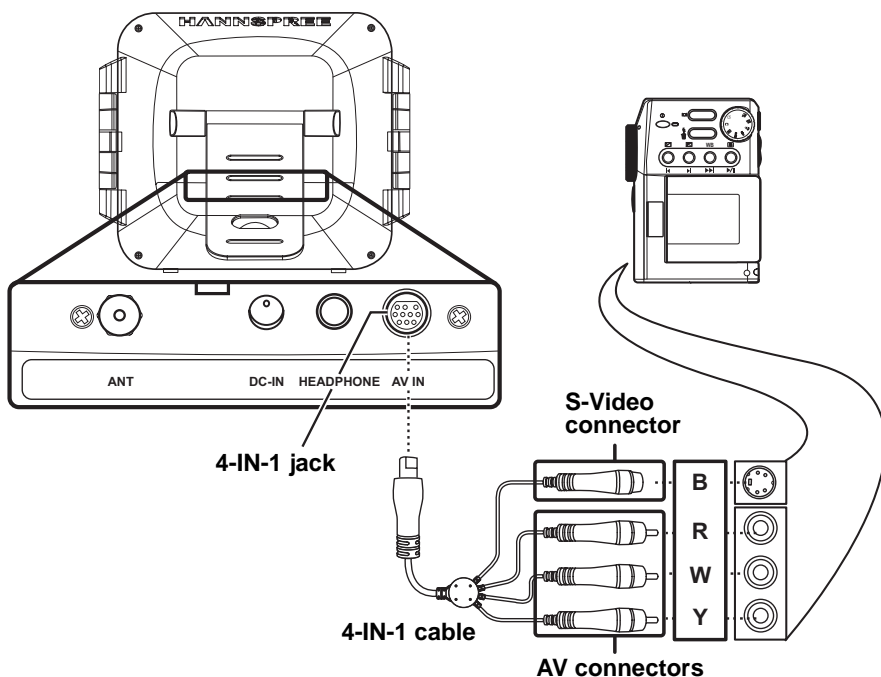

### Note

The cables are color-coded (black, red, white, yellow). Connect each color-coded cable to the appropriate connector on your device.

---

## Connecting to a Game Device

The instructions presented here are a general guide to connecting the TV to a game device using the RCA Jacks provided (some game devices may require a unique adapter that is not provided). Actual connections may vary according to the make and model of the game device. Refer to the user's manual included with the game device for more detailed instructions.

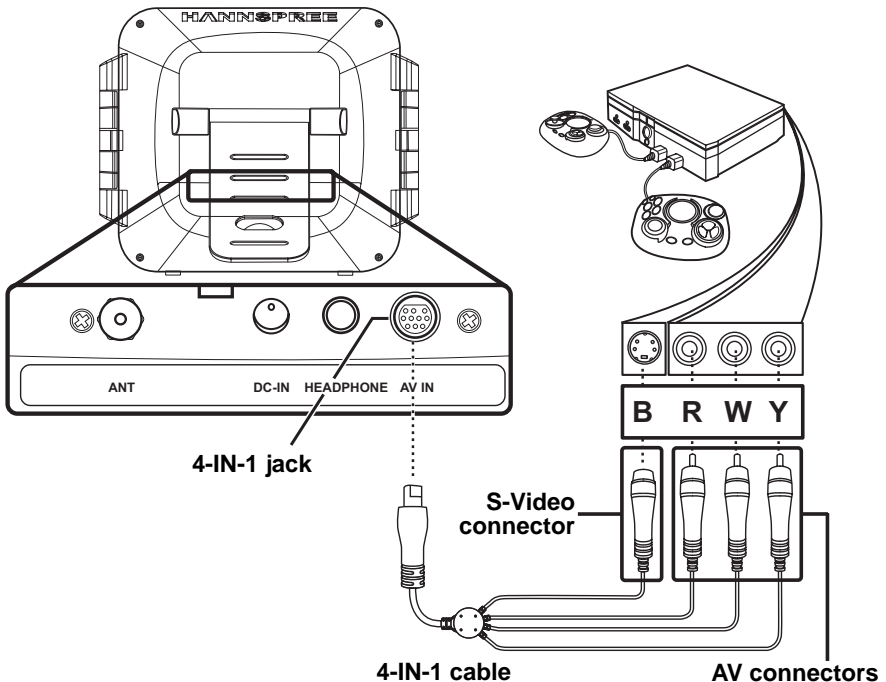

### Notes

- Connect the 4-IN-1 cable connectors to the corresponding connectors on your game device adapter.
- If the 4-IN-1 cable does not fit the game device, then insert the included RCA jack between the 4-IN-1 cable and the game device.

---

## Connecting External Speakers or Headphones

External speakers or headphones may be used to listen to the TV rather than using the built-in speakers. Connect external speakers or headphones to the headphone line out port as illustrated.

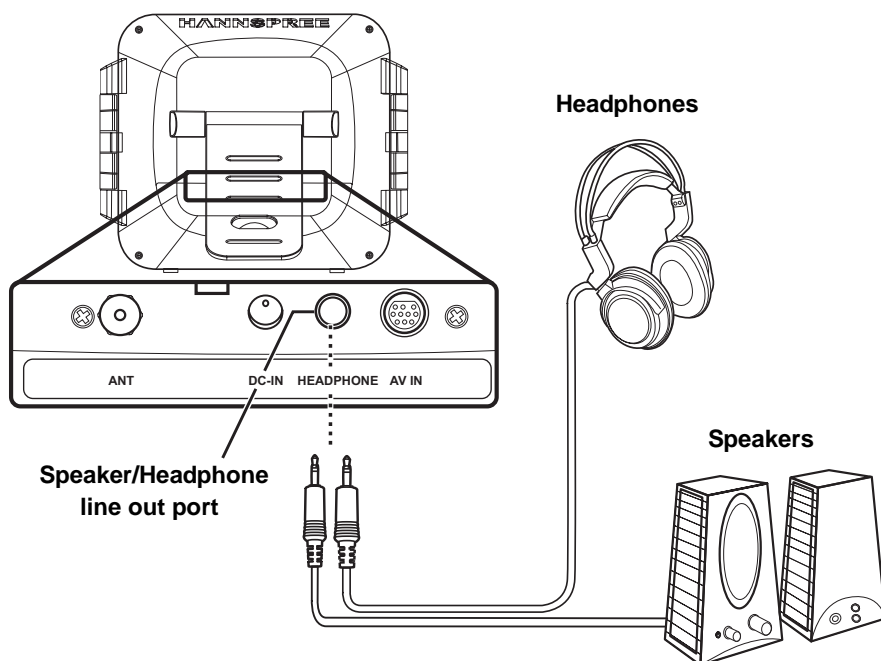

### Notes

- External speakers or headphones are not included with the product.
- The internal TV speakers will not output sound when headphones are plugged in.
- Use external speakers with amplifiers only.

---

## Connecting the Power Adapter

- 1 Connect the power cord to the power adapter as illustrated.
- 2 Plug the power adapter connector into the DC-IN input jack on the rear panel of the TV.
- 3 Insert the three-pronged plug at the other end of the power cord into a power outlet.

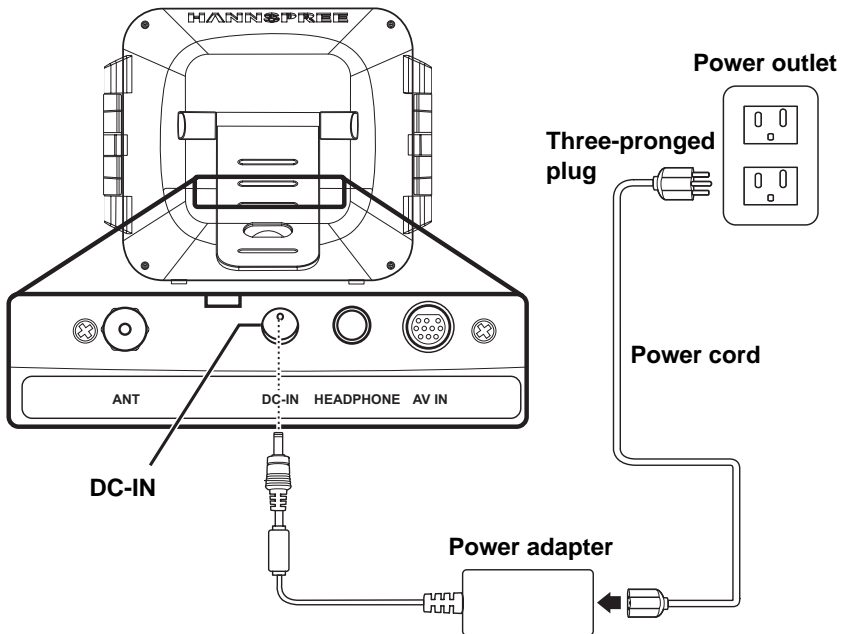

### Using the Remote Control

For best results, use the remote control within a distance of 5 meters from the front of the TV's signal sensor. Do not exceed an angle of 30 degrees when pointing at the signal sensor. Refer to the following illustration.

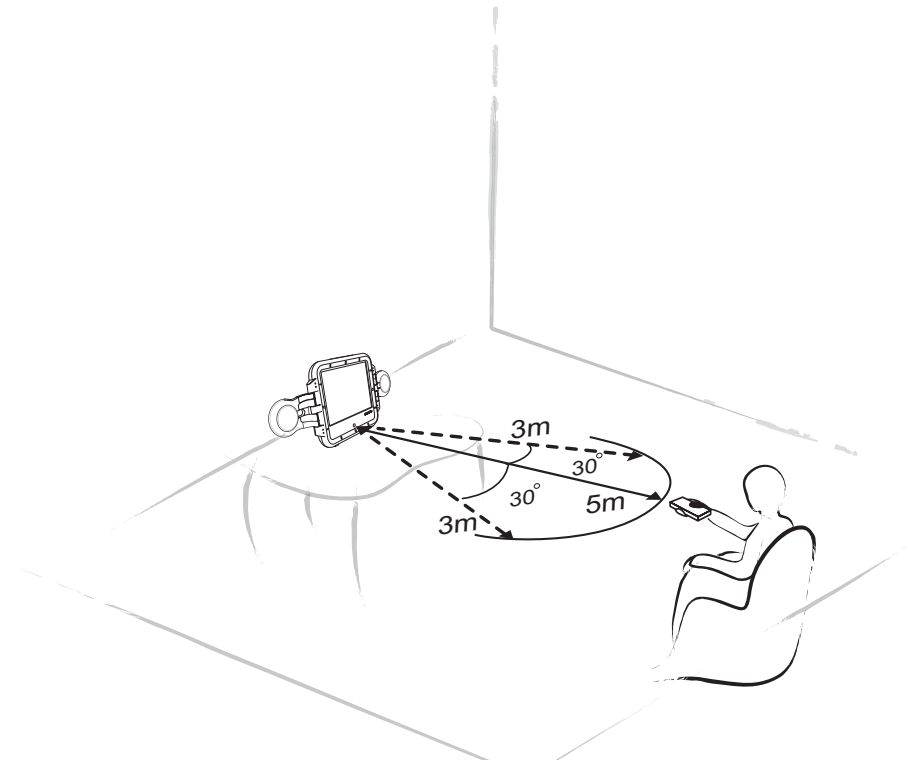

---

## Turning the TV On and Off

- 1 Press the **POWER** button on the remote control (or control panel). The power LED on the front of the TV changes from dark to green, indicating that the power has been turned on.
- 2 Press the **POWER** button again; the power LED changes from green to dark, indicating that the TV is in off mode.

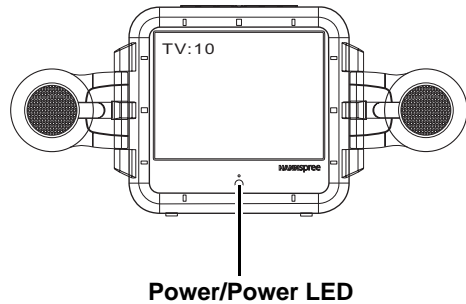

## Selecting Channels

Press the **CH UP** button and the **CH DOWN** button on the control panel to select the channel or enter the specific channel number by pressing the number buttons on the remote control.

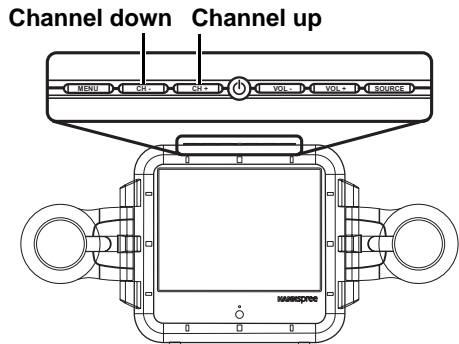

## Switching Source Signals

Press **SOURCE** on the remote control or control panel to select the incoming source signal.

The current source setting (TV/CATV, S-Video, or AV) appears on the top left corner of the screen.

### Note

The TV supports S-Video input in addition to normal video and audio signals.

## Adjusting the Volume

Press the **VOL UP** button to increase the volume. Press the **VOL DOWN** button to decrease the volume. The volume level is displayed on the TV.

Press **MUTE** on the remote control to turn the sound off. Press **MUTE** on the remote control or press **VOL UP / VOL DOWN** to turn the sound on.

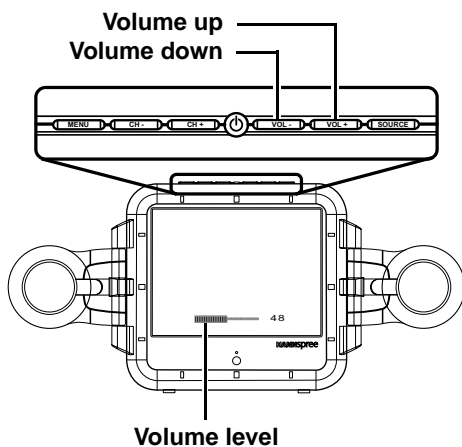
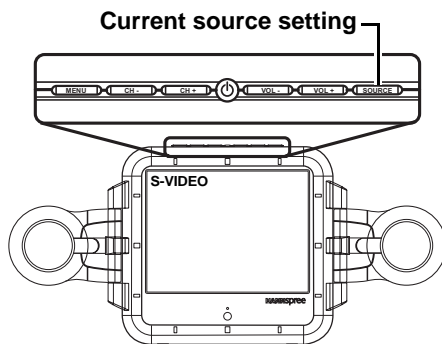

## Adjusting On-Screen Display (OSD) Settings

The On-Screen Display (OSD) menu system provides a quick and simple method to adjust your TV's settings. This chapter describes how to change each of the available settings.

The OSD can be used with either the remote control or the front control panel.

Button Descriptions	Control Panel
MENU	MENU
CH UP	CH +
CH DOWN	CH -
MENU	MENU

The following sections explain how to adjust settings in the OSD menus using the control panel

**OSD Setting Menu**

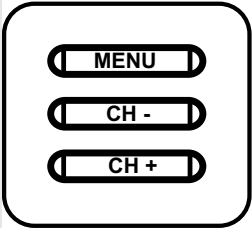

Press the **MENU** button to enter the OSD menus.

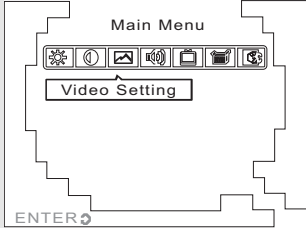

The Main Menu appears

### Note

To exit the OSD menus at any time, press the **CH UP** button or **CH DOWN** to select Exit . Then press **MENU** to exit the OSD menus. Also, after you finish setting OSD parameters, follow these instructions to exit the OSD menus; alternatively, wait 15 seconds for the OSD to close automatically.



## Brightness

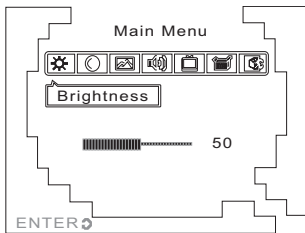

- 1 Press **MENU** to enter the OSD menus.
- 2 Press the **CH UP** button or **CH DOWN** button to select Brightness.
- 3 Press **MENU**. The brightness slide bar appears.
- 4 Press the **CH UP** button to increase the brightness.
- 5 Press the **CH DOWN** button to decrease the brightness.
- 6 Press **MENU** to confirm the setting and return to the Main menu.

### Notes

The new setting is confirmed automatically when the OSD times out.

	MAX	MID	MIN
BRIGHTNESS	100	50	0

## Contrast

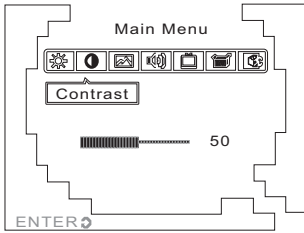

- 1 Press **MENU** to enter the OSD menus.
- 2 Press the **CH UP** button or **CH DOWN** button to select Contrast.
- 3 Press **MENU**. The contrast slide bar appears.
- 4 Press the **CH UP** button to increase the contrast.
- 5 Press the **CH DOWN** button to decrease the contrast.
- 6 Press **MENU** to confirm the setting and return to the Main menu.

### Note

The new setting is confirmed automatically when the OSD times out.

	MAX	MID	MIN
CONTRAST	100	50	0

## Video Setting

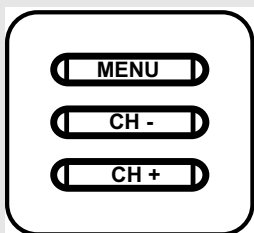

Press the **MENU** button to enter the OSD menus.

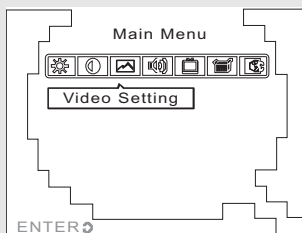

- 1** Press the **CH UP** button or **CH DOWN** button to select Video Setting.
- 2** Press **MENU** to enter the Video Setting menu.

## Hue

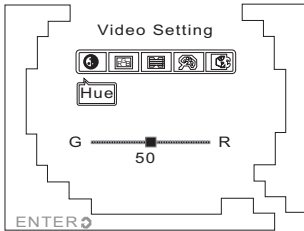

- 1 Press the **CH UP** button or **CH DOWN** button to select Hue.
- 2 Press **MENU** to enter the Hue menu.
- 3 Press the **CH UP** button to increase the hue towards the red spectrum. The image becomes more red.
- 4 Press the **CH DOWN** button to decrease the hue towards the green spectrum. The image becomes more green.
- 5 Press **MENU** to confirm the setting and return to the Video Setting menu.

### Note

The new setting is confirmed automatically when the OSD times out.

	MAX	MID	MIN
HUE	100	50	0

---

## Saturation

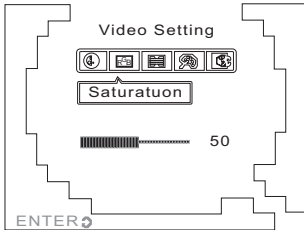

- 1 Press the **CH UP** button or **CH DOWN** button to select Saturation.
- 2 Press **MENU** to enter the Saturation menu.
- 3 Press the **CH UP** button to increase the saturation. The screen image becomes more vibrant.
- 4 Press the **CH DOWN** button to decrease the saturation. The screen image becomes less vibrant.
- 5 Press **MENU** to confirm the setting and return to the Video Setting menu.

### Note

The new setting is confirmed automatically when the OSD times out.

	MAX	MID	MIN
SATURATION	100	50	0

## Sharpness

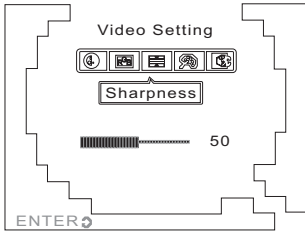

- 1 Press the **CH UP** button or **CH DOWN** button to select Sharpness.
- 2 Press **MENU** to enter the Sharpness menu.
- 3 Press the **CH UP** button to increase the sharpness.
- 4 Press the **CH DOWN** button to decrease the sharpness.
- 5 Press **MENU** again to confirm the setting and return to the Video Setting menu.

### Note

The new setting is confirmed automatically when the OSD times out.

	MAX	MID	MIN
SHARPNESS	100	50	0

---

## Color Temperature

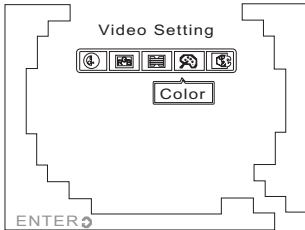

- 1 Press the **CH UP** button or **CH DOWN** button to select Color.
- 2 Press **MENU** to enter the Color menu. The following three color temperatures are available.

### Standard Color

Press the **CH UP** button or **CH DOWN** button to select Standard, then press **MENU**.

### Warm Color

Press the **CH UP** button or **CH DOWN** button to select Warm, then press **MENU**.

### Cold Color

Press the **CH UP** button or **CH DOWN** button to select Cold, then press **MENU**.

## Audio Setting

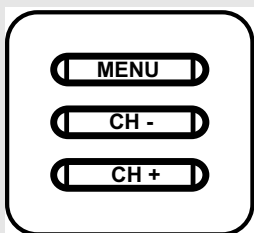

Press the **MENU** button to enter the OSD menus.

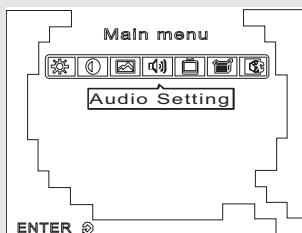

- 1** Press the **CH UP** button or **CH DOWN** button to select Audio Setting.
- 2** Press **MENU** to enter the Audio Setting menu.



---

## Treble

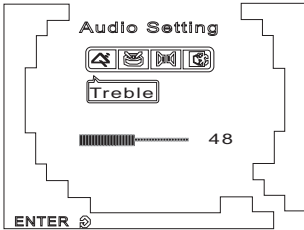

- 1 Press the **CH UP** button or **CH DOWN** button to select Treble.
- 2 Press **MENU** to enter the Treble menu.
- 3 Press the **CH UP** button to increase the treble.
- 4 Press the **CH DOWN** button to decrease the treble.
- 5 Press **MENU** to confirm the setting and return to the Audio Setting menu.

### Note

The new setting is confirmed automatically when the OSD times out.

	MAX	MID	MIN
Treble	100	50	0

## Bass

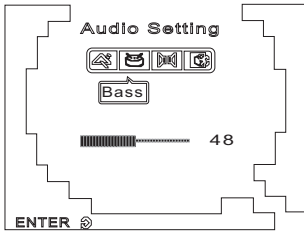

- 1 Press the **CH UP** button or **CH DOWN** button to select Bass.
- 2 Press **MENU** to enter the Bass menu.
- 3 Press the **CH UP** button to increase the bass.
- 4 Press the **CH DOWN** button to decrease the bass.
- 5 Press **MENU** to confirm the setting and return to the Audio Setting menu.

### Note

The new setting is confirmed automatically when the OSD times out.

	MAX	MID	MIN
Bass	100	50	0

---

## Balance

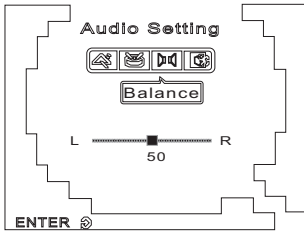

- 1 Press the **CH UP** button or **CH DOWN** button to select Balance.
- 2 Press **MENU** to enter the Balance menu.
- 3 Press the **CH DOWN** button to shift the balance to the left speaker.
- 4 Press the **CH UP** button to shift the balance to the right speaker.
- 5 Press **MENU** to confirm the setting and return to the Audio Setting menu.

### Note

The new setting is confirmed automatically when the OSD times out.

	MAX	MID	MIN
Balance	R (100)	50	L (0)

## TV Setting

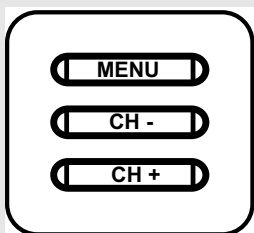

Press the **MENU** button to enter the OSD menus.

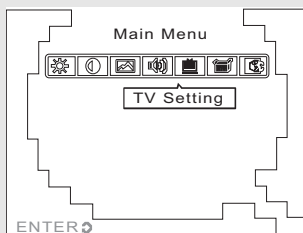

- 1** Press the **CH UP** button or **CH DOWN** button to select TV Setting.
- 2** Press **MENU** to enter the TV Setting menu.

---

## TV/CATV

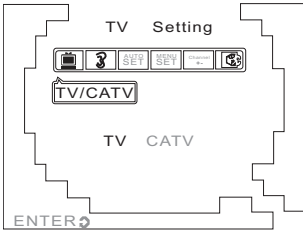

- 1 Press the **CH UP** button or **CH DOWN** button to select TV/CATV.
- 2 Press **MENU** to enter the TV/CATV menu. The following choices are available.

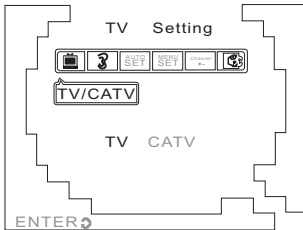

### Receiving Broadcast TV

Press the **CH UP** button or **CH DOWN** button to select TV, then press **MENU**.

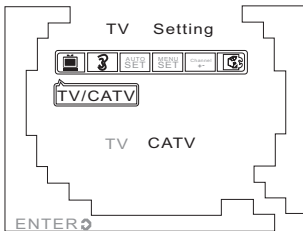

### Receiving Cable TV

Press the **CH UP** button or **CH DOWN** button to select CATV (default), then press **MENU**.

## MTS

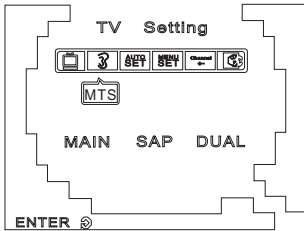

- 1 Press the **CH UP** button or **CH DOWN** button to select MTS.
- 2 Press **MENU** to enter the MTS menu.

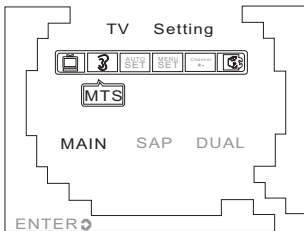

## MAIN

- 1 Press the **CH UP** button or **CH DOWN** button to select MAIN (default). MAIN is highlighted in red.
- 2 Press **MENU** again to confirm the selection.

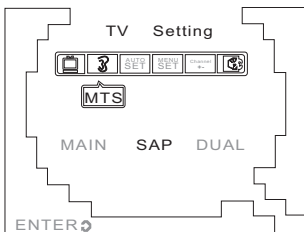

## SAP

- 1 Press the **CH UP** button or **CH DOWN** button to select SAP. SAP is highlighted in red.
- 2 Press **MENU** again to confirm the selection.

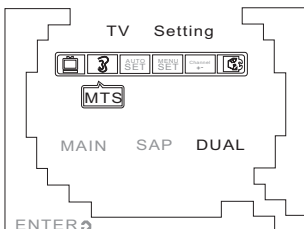

## DUAL

- 1 Press the **CH UP** button or **CH DOWN** button to select DUAL. DUAL is highlighted in red.
- 2 Press **MENU** to confirm the selection.

---

## Auto Program

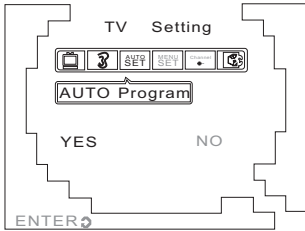

- 1 Press the **CH UP** button or **CH DOWN** button to select Auto Program.
- 2 Press **MENU** to enter the Auto Program menu.
- 3 Press the **CH UP** button or **CH DOWN** button to select Yes or No.
- 4 Press **MENU**.

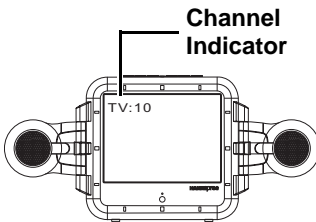

The screen goes blank and the channel indicator values range from 2 to 69 (antenna connection) or from 1 to 125 (CATV cable connection).

The screen displays the first channel that is successfully found after scanning is complete.

---

## Manual Program

This function allows you to locate channels for adding to or erasing from preset channels.

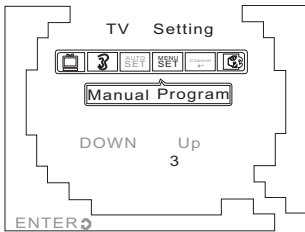

- 1** Press the **CH UP** button or **CH DOWN** button to select Manual Program.
- 2** Press **MENU** to enter the Manual Program menu.
- 3** Press the **CH UP** button or **CH DOWN** button to find the channel you want to add.
- 4** When you have found the channel, press **MENU**.



---

## Channel Add/Erase

Channel to be added or erased must be selected from manual program.

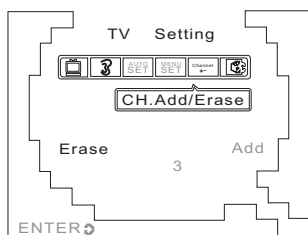

- 1 Press the **CH UP** button or **CH DOWN** button to select CH. Add/Erase.
- 2 Press **MENU** to enter the CH. Add/Erase menu. Select one of the following options.

### Add Channel

- 1 Press the **CH UP** button to select Add.
- 2 Press the **MENU** to add the selected channel.

### Erase Channel

- 1 Press the **CH DOWN** button to select Erase.
- 2 Press **MENU** to delete the selected channel.

When you return to the normal TV screen and use the **CH UP / CH DOWN** button to browse channels, the deleted channel (for example, Channel 3) is skipped automatically.

#### Note

You can still access the deleted channel by entering the channel number using the number buttons on the remote control.

## Miscellaneous Setting

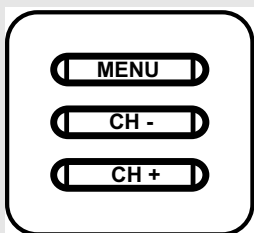

Press the **MENU** button to enter the OSD menus.

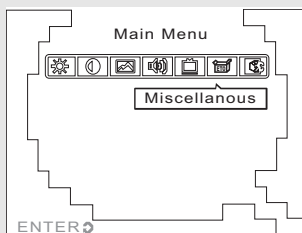

- 1** Press the **CH UP** button or **CH DOWN** button to select Miscellaneous.
- 2** Press **MENU** to enter the Miscellaneous menu.

---

## OSD Position

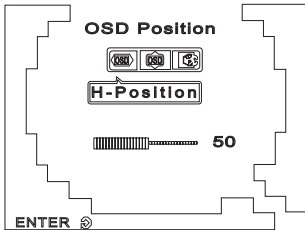

**1** Press the **CH UP** button or **CH DOWN** button to select OSD Position.

**2** Press **MENU** to enter the OSD Position menu.

The following options are available.

### Horizontal Position

**1** Press the **CH UP** button or **CH DOWN** button to select H. Position.

**2** Press **MENU**.

**3** Press the **CH DOWN** button to move the OSD screen to the left. Press the **CH UP** button to move the OSD screen to the right.

**4** Press **MENU** to confirm the setting.

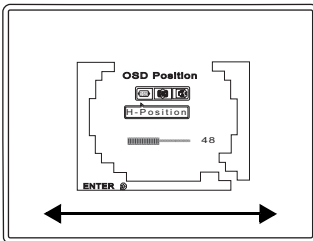

### Vertical Position

**1** Press the **CH UP** button or **CH DOWN** button to select V. Position.

**2** Press **MENU**.

**3** Press the **CH DOWN** button to move the OSD screen downward. Press the **CH UP** button to move the OSD screen upward.

**4** Press **MENU** to confirm the setting.

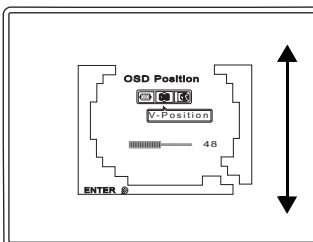

---

## Language

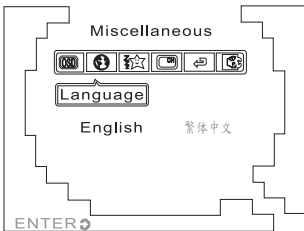
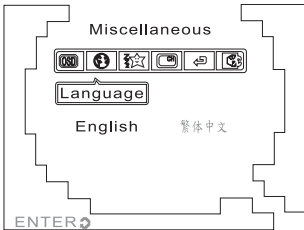

- 1** Press the **CH UP** button or **CH DOWN** button to select Language.
- 2** Press **MENU** to enter the Language menu.  
The screen displays the available OSD languages: English and T-Chinese (Traditional Chinese).
- 3** Press the **CH UP** button or **CH DOWN** button to select a language.
- 4** Press **MENU** to confirm your choice.

### Note

The default language setting is Tranditional Chinese.

---

## Sleep Timer

The sleep timer turns the TV off automatically after a set period of time.

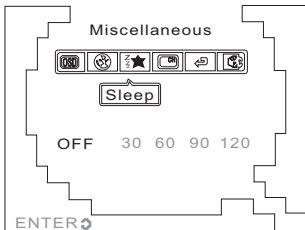

- 1** Press the **CH UP** button or **CH DOWN** button to select Sleep.
- 2** Press **MENU** to enter the Sleep menu.
- 3** The screen displays the available sleep timer setting:
  - Off
  - 30 minutes
  - 60 minutes
  - 90 minutes
  - 120 minutes



- 4** Press the **CH UP** button or **CH DOWN** button to select a setting.
- 5** Press **MENU** to confirm your choice.

---

## OSD Display

This setting allows you to set whether information such as the selected channel is shown on the TV screen when the **DISPLAY** button is pressed.

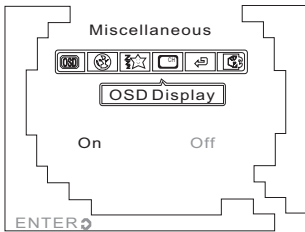

- 1** Press the **CH UP** button or **CH DOWN** button to select **OSD Display**.
- 2** Press **MENU** to enter the OSD Display menu.
- 3** Press the **CH UP** button or **CH DOWN** button to select On or Off.
- 4** Press **MENU** to confirm your choice.

---

## Reset

The Reset function returns all of your TV's user settings to their factory defaults.

### Warning:

The reset function will erase all of your custom and favorite channel settings, and will reset all display settings (such as contrast, brightness, etc.) to the factory default values. The reset function cannot be reversed once it begins.

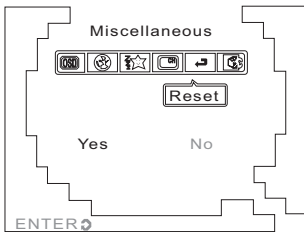

- 1 Press the **CH UP** button or **CH DOWN** button to select Reset.
- 2 Press **MENU** to enter the Reset menu.
- 3 Press the **CH UP** button or **CH DOWN** button to select Yes or No. By default, No is already selected (highlighted in red).
- 4 Press **MENU** to confirm your choice.



Turn the power off before you begin cleaning the TV.

---



For best results, use a clean lens cloth to remove dust and fingerprints from the screen.

---



Do not wipe the shell of the TV with alcohol, methanol, gasoline or oil products to avoid damaging the finish. Wipe the shell with a dry soft cloth and use neutral cleaning fluids.

---

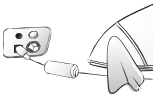

If your model has leather components, wipe the leather parts with a dry cloth and keep the area dry. Place the TV far from sources of steam to avoid making the leather wet.

---



Be careful to remove the power plug correctly. Hold the plug instead of pulling the power cord.

---

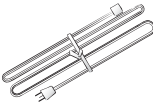

Arrange the power cord with other cords to avoid knotting or bending which may cause fire due to damage or electric leakage.

---



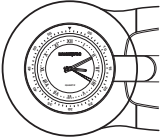

#### Notices for using the clock

- Don't try to open or remove the case.
- If there's any condensation on the surface, contact the dealer or return the clock to the factory for service.
- Don't use the clock in an environment of extreme temperatures.
- The clock is designed for normal use. Use it carefully and do not drop the clock.
- Dampen a soft, dry cloth with water or a neutral detergent to wipe the clock. Be sure not to use volatile chemicals such as benzene, thinners, or spray detergents.
- Prevent the clock from coming into contact with cosmetics such as hair spray, cologne, or sun protection oil. Cosmetics may damage the plastic parts of the clock. If the clock comes into contact with cosmetics, clean the clock with a soft, dry cloth.
- Avoid using the clock where gasoline, detergents, sprays, binders, or paints are present. The chemical reaction caused by these chemicals will damage the sealing O-ring, case, and surface of the clock.

Situation	Solution
No picture and sound.	<ul style="list-style-type: none"> <li>• Connect the power cord properly.</li> <li>• Press the <b>POWER</b> button on the control panel or remote control.</li> <li>• Press the <b>SOURCE</b> button to cycle through connected video sources.</li> <li>• Press the <b>CH UP</b> or <b>CH DOWN</b> to switch to other TV stations.</li> <li>• Check the TV/CATV OSD settings. See "TV/CATV" on page 44.</li> <li>• Make sure all cables are connected properly.</li> </ul>
No picture, or poor picture, sound is OK.	<ul style="list-style-type: none"> <li>• Check the antenna and cable connections.</li> <li>• Adjust the brightness in the OSD menus. See "Brightness" on page 32.</li> </ul>
Picture is not in color.	<ul style="list-style-type: none"> <li>• Adjust the saturation in the OSD menus. See "Saturation" on page 36.</li> </ul>
Picture is OK, no sound.	<ul style="list-style-type: none"> <li>• Press the <b>VOL UP</b> button on the control panel or remote control.</li> <li>• Make sure the MTS option is set to Main or Dual. See "MTS" on page 45.</li> </ul>
One of the speakers has no sound.	<ul style="list-style-type: none"> <li>• Adjust the balance in the OSD menus. See "Balance" on page 42.</li> </ul>
Can't receive some TV channels using cable TV.	<ul style="list-style-type: none"> <li>• Try the Auto Program function in the OSD "TV Setting" menu. See "Auto Program" on page 46.</li> </ul>
Want to reset TV settings.	<ul style="list-style-type: none"> <li>• Use the Reset function in the OSD menu.</li> </ul>
Cannot operate menus.	<ul style="list-style-type: none"> <li>• If OSD items are colored light blue, the system is in a state such that those settings are not available. For example, video setting is available in TV mode.</li> </ul>
No image but have sound.	<ul style="list-style-type: none"> <li>• Make sure the video signal cable is connected properly.</li> </ul>

Situation	Solution
No sound but have image.	<ul style="list-style-type: none"> <li>• Make sure the source device is functioning properly.</li> <li>• Set the volume to a higher level.</li> <li>• Make sure the audio cable is connected securely.</li> <li>• Turn the mute off.</li> </ul>
Screen image turns over.	<ul style="list-style-type: none"> <li>• Make sure the video signal cable is connected properly.</li> </ul>
Snow appears on the screen.	<ul style="list-style-type: none"> <li>• Adjust the location of the antenna, placing it far from roads or sources of interference.</li> <li>• Check the antenna and the video signal line connections.</li> </ul>
Blurred or overlapped images.	<ul style="list-style-type: none"> <li>• Readjust the sharpness setting.</li> <li>• Choose programs with high quality signals.</li> <li>• Adjust the direction of the antenna or change the video signal cable.</li> </ul>

<b>F651-12A1</b>	
LCD Panel Size	12.1-inch TFT
Aspect Ratio	4:3
Best Resolution	800 (horizontal) x 600 (vertical)
Maximum Display Area	246 mm (H) x 184.5mm (W)
TV System	NTSC
Video System	S-Video Input and Composite Video Input (through the 4-IN-1 cable)
Audio System	Input: RCA Jack (L/R Audio Input through the 4-IN-1 cable) Output: 3.5mm ø headphone jack x 1
Built-in Speakers	3W + 3W
Power Supply	100-240V, 50/60 Hz, 12V DC
Power Consumption	40W (Average)
Power Consumption (Standby)	0.9W Maximum
Optional Accessories	External Speakers
Weight (including base)	3.65 kg
Dimensions (including base)	366 mm (H) x 306 mm (W) x 180 mm (D)

**Aspect Ratio** The ratio of width to height of a film, image or display screen.

**Broadcast TV** Broadcasting video signals using high-frequency electromagnetic waves to distribute television channels to viewers (standard TV broadcast).

**CATV** Community Antenna Television, the original name for cable TV. A television distribution system that uses coaxial cable instead of the traditional radio broadcasting (over-the-air) method to deliver television, FM radio, and other services to consumers.

**Color Temperature** Adjusting the color temperature enables you to set the intensity of white light. Color temperature is measured in Kelvin (K). Higher color temperatures result in a blue tint. Lower temperatures result in a red tint.

**DUAL** Used with SAP and NTSC, enables broadcast of the main broadcast signal on one speaker, and the alternate audio speaker on the other speaker.

**Hue** Colors in a color system are measured by hue, saturation and luminance. Hue indicates the predominant color.

**LCD** Liquid Crystal Display. A display technology that uses rod-shaped molecules (liquid crystals) that flow like liquid and bend light.

**Main** is the default audio signal belonging to a particular channel.

**MTS** Multi-channel Television Sound. Enables reception of audio other than the primary (MAIN) audio signal. DUAL enables reception of a stereo audio signal, while SAP (Second Audio Program) enables reception of a separate channel that may be a different language or completely different information such as the news.

**RCA connector** An RCA or phono connector is a plug and socket for a two-wire (signal and ground) coaxial cable that is widely used to connect audio and video components. RCA sockets are commonly found at the rear of audiovisual equipment.

**RCA jack** An RCA jack enables you to attach the 4-IN-1 cable to a device socket. Refer to "Checking Package Contents" on page 17 and "Connecting to a Game Device" on page 25.

**SAP** (Secondary Audio Program) is an audio channel used with the NTSC TV standard for auxiliary transmission of such items as foreign language broadcasting or teletext.

**Saturation** Chromatic purity indicating the amount of white contained in a color. Fully saturated colors are pure colors; less saturated colors appear as pastel shades.

---

**S-Video** Super-video, a video cabling standard used to transmit video by keeping brightness (Y) and color information (C) on separate channels. Most often used with camcorders, VCRs, and quality receivers and amplifiers to provide sharper pictures.

**VCD** A compact disk format developed in 1993 by Sony and Philips to capture full-motion video. A standard Video CD can hold 74 minutes of near VHS-quality video and CD-quality sound.